

MS010620



Operation Manual

Specification T = 25°C

Operating Frequency	1...6 GHz
RF Saturated Output Power	33...41 W
RF Output Power @ at $P_{in} = 3$ dBm	30...40 W
Small Signal Gain	55 – 65 dB
Small Signal Gain Flatness	3 dB Typ.
Input VSWR	2.0:1 Max
Operating Voltage	+27 V
Maximum Operating Current	7 A ¹⁾
RF input overdrive	15 dBm Max
Signal Source VSWR	2.0:1 Max
Output Load VSWR	2.0:1 Max
Power Detector Load	1 kOhm
RF connector, Input / Output / Impedance	SMA Female / 50 Ohm
Cooling	External Heatsink
Dimensions	168.1 x 78.2 x 23.8 mm
Weight	0.45 kg
Operating Temperature (baseplate)	-55...75 °C
Storage Temperature	-65...85 °C
Relative Humidity	98 %

¹⁾ Maximum Operating Current can grow by 10% at case temperature below T = -20°C

Amplifier Use:

- ❖ The amplifier operational baseplate temperature must be within the operational temperature range stated in the amplifier operation manual. Depending on the design and thermal requirements, using a heatsink with cooling fan is always recommended for safe reliable operation. A heat sink without a cooling fan may also be used. Damage caused from overheating will void the warranty.
- ❖ Confirm the system is designed and calibrated for 50 Ohms. Any impedance mismatch may cause performance issues.
- ❖ Confirm the amplifier output load is matched for a 50 Ohm impedance and will not exceed the maximum output load VSWR limit for the amplifier. Exceeding the maximum output load VSWR limit will result in reflected signal that could damage the amplifier and void the warranty.
- ❖ Confirm adequate system grounding is established. The DC power supply and amplifier must have a common ground in order to operate properly.
- ❖ Power supply must be able to provide adequate current for the amplifier. Power supply should be able to provide 1,5 times the typical current or 1,2 times the maximum current (whichever is greater).
- ❖ As long as the input and output ports of the amplifier are connected to a 50 Ohm load and RF-signal is applied, the amplifier can be powered up with DC voltage.
- ❖ Ensure that the power and DC voltage is off then connecting or disconnecting the input or output of the amplifier.
- ❖ Exceeding absolute maximum ratings shown will damage the amplifier.
- ❖ The amplifier is static sensitive. Always follow ESD rules when working with amplifier.



Connection Procedure:

- 1) RF connectors. Connect «RF IN» and «RF OUT» to 50 Ohm source / load.
- 2) X2 Connector. Connect Pin#B to DC Ground. Connect Pin#A on X2 to DC +27V biasing. Pin#1 and Pin#2 leave unconnected.
- 3) X1 Connector. Connect DC +5V/0V (TTL Logic High/Low) to Pin#9 and DC Ground to Pin#7. Connect DC +5V/0V (TTL Logic High/Low) to Pin#1 – Pin#5 to enable control of built-in attenuator.
- 4) Turning on the amplifier. Enable +27V DC (X2) and then enable DC +5V Pin #9 (X1) to turn on the RF signal.

The device will have maximum available gain at these conditions. To turn on the attenuator bit enable DC +5V to the necessary pin (Pin#1 – Pin#5 X1). It is possible to combine and use multiple bits at the same time.

Connectors

RF IN

RF input. Connect to 50 Ohm source. Do not exceed the maximum input power of +15 dBm, higher input power may damage the amplifier.

RF OUT

RF output. Connect to 50 Ohm load.

Pin#A (X2) / +26...+30 V DC power supply input

Use an appropriate power supply with an output voltage of +26...+30 V DC and an output current of 15 A.

Pin#B (X2)

Must be connected to the ground (return) connector of the power supply unit.

Pin#1, Pin#2 (X2)

No connection.

Pin#1 – Pin#5 (X1)

Enable control of built-in attenuator. To turn on the attenuator bit enable DC +5V (TTL Logic High) to the necessary pin.

Pin#1 – Bit 16 control

Pin#2 – Bit 8 control

Pin#3 – Bit 4 control

Pin#4 – Bit 2 control

Pin#5 – Bit 1 control

Typical small signal gain (turn on the attenuator bits)

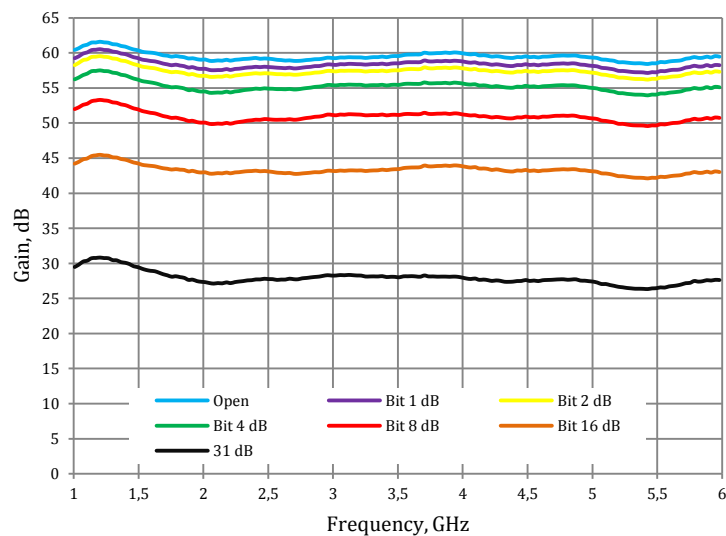

Pin#6 (X1) Output voltage of built-in output power detector

The output provides a DC voltage proportional to the forward output power of the amplifier.

Load Pin#6 on X1 connector at 1 kOhm and measure output power level using DC-tester or multimeter.

Typical power detector level vs. frequency @ $P_{out} = 43$ dBm

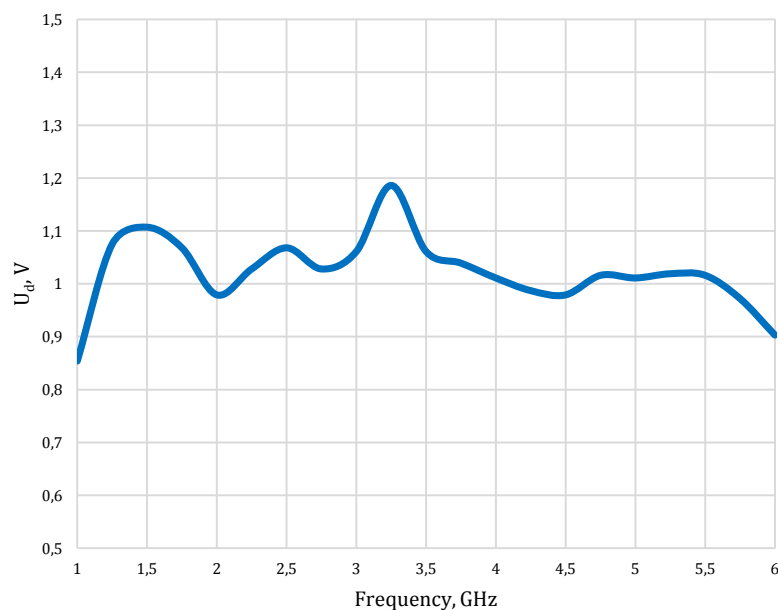

Pin#8 (X1) Output voltage of built-in output temperature sensor

This output provides a voltage proportional to the internal temperature of the amplifier. The voltage range of this output is 0...3 V DC (the type of temperature sensor is LM20BIM7 National Semiconductor).

Measure voltage level using DC-tester or multimeter.

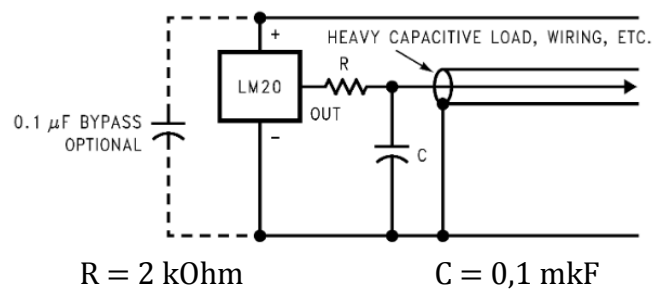
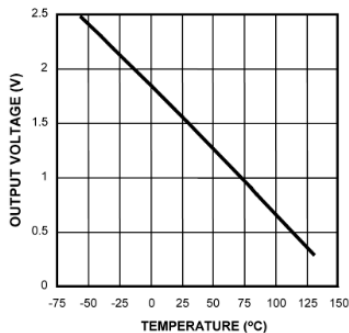

$$V_O = (-3.88 \times 10^{-6} \times T^2) + (-1.15 \times 10^{-2} \times T) + 1.8639$$

$$T = -1481.96 + \sqrt{2.1962 \times 10^6 + \frac{(1.8639 - V_O)}{3.88 \times 10^{-6}}}$$

Pin#9 (X1) Enable / disable of the amplifier

The input voltage range is +2.4...5 V DC (TTL High Level). The voltage on this Pin enabling the amplifier. After applying a voltage on this Pin the amplifier goes activate and with RF input power the oscilloscope shot of the detected output signal is showed below.

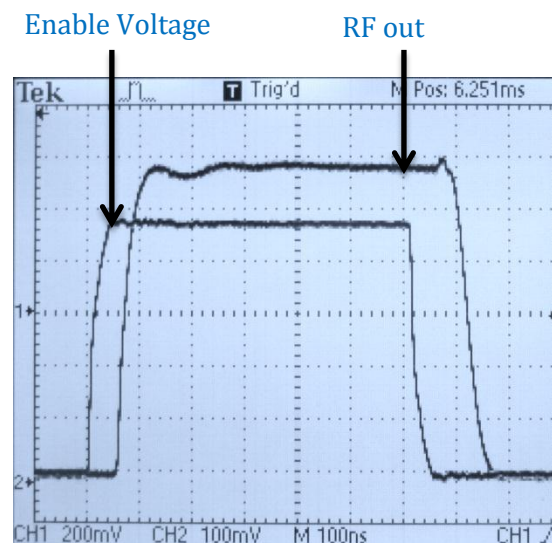

Pin#7, Pin#10

DC ground.

Gain-temperature compensation

The amplifier contains a built-in gain-temperature compensation.

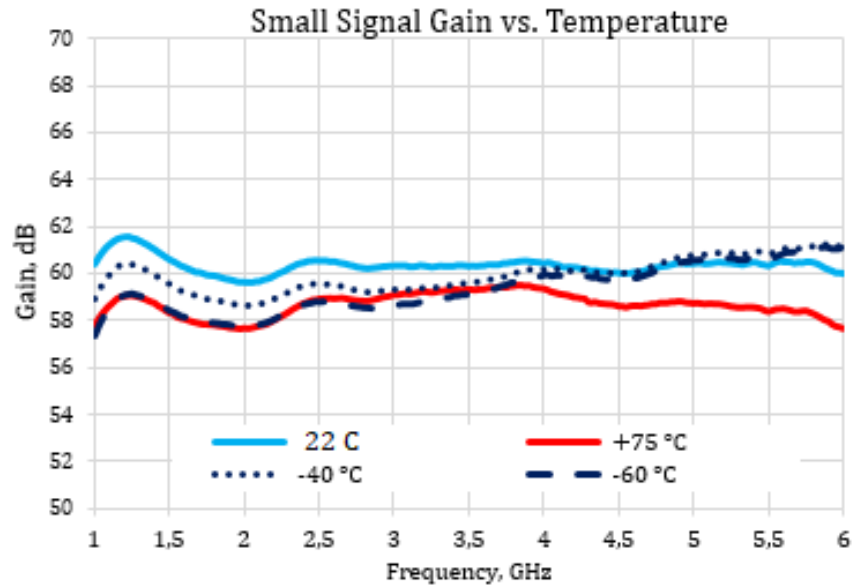

Mechanical Outline

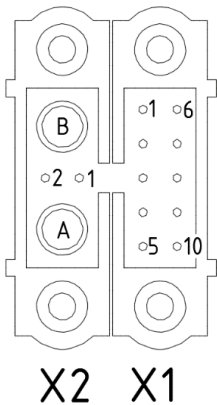
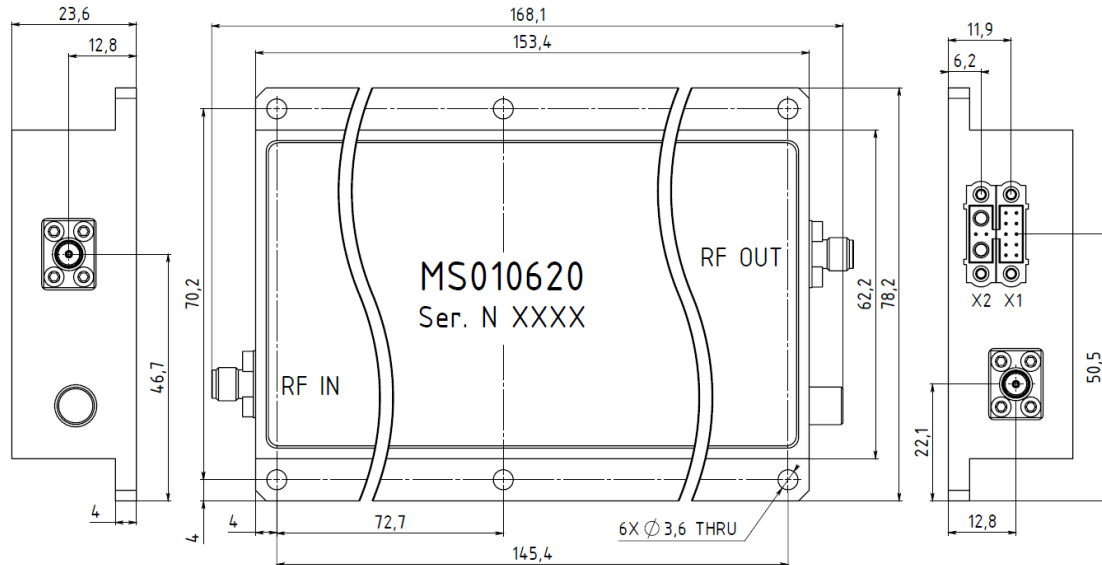

Connector	Pin#	Description	Specification
X1	1	16	Bit 16 dB control
	2	8	Bit 8 dB control
	3	4	Bit 4 dB control
	4	2	Bit 2 dB control
	5	1	Bit 1 dB control
	6	DOUT	Power Detector Output
	7,10	G	Ground
	8	T	Analog Voltage Relative Temperature@10mV/°C
	9	Mod	RF Enable (0V or GND=RF Off, +5V or NC=RF On)
	X2	A	+27
B		G(-27)	Ground
1,2		N/C	No Connection

Connector	Socket Type	Plug Type*
X1	Harwin : M80-5101022	Harwin : M80-4611042
X2	Harwin : M80-5T10222M2-01-331-01-331	Harwin : M80-4C102422F1-01-325-01-325

*Each amplifier includes M80-4611042 and M80-4C102422F1-01-325-01-325 interface connectors